

Vedlegg 4 til UD 9-17-3

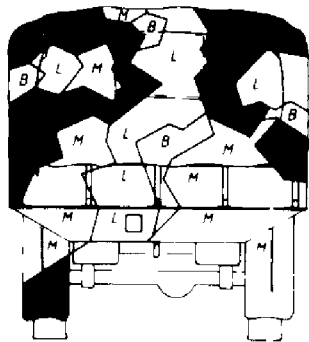

M 621

Vedlegg 4 til UD 9-17-3

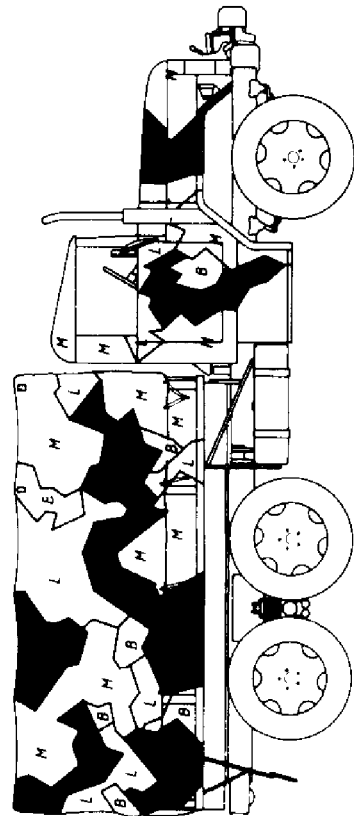
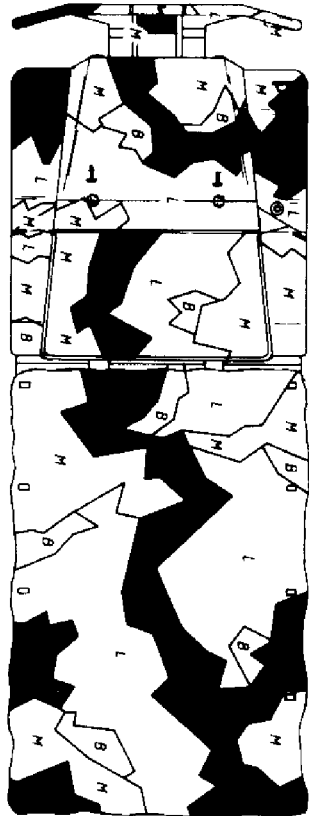
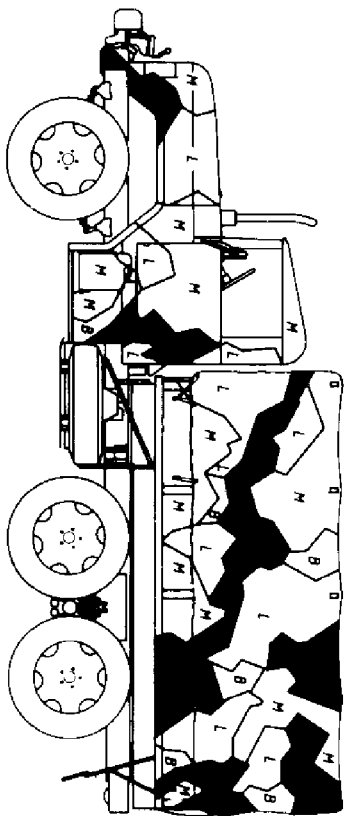
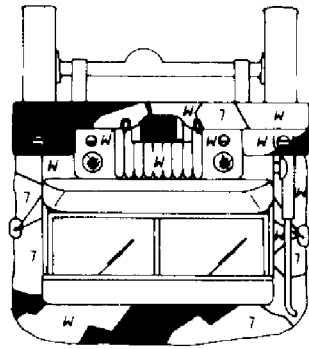
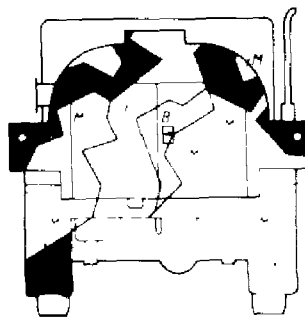
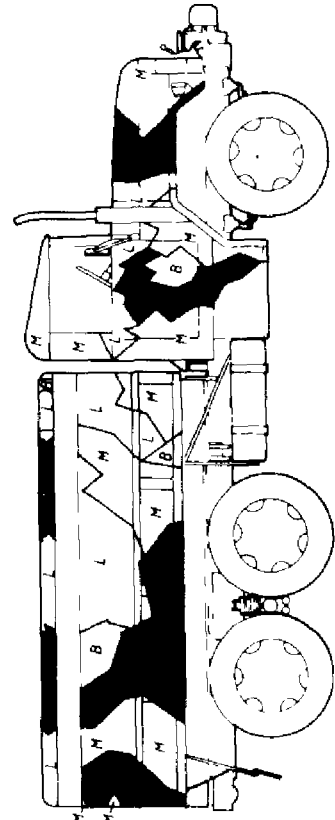
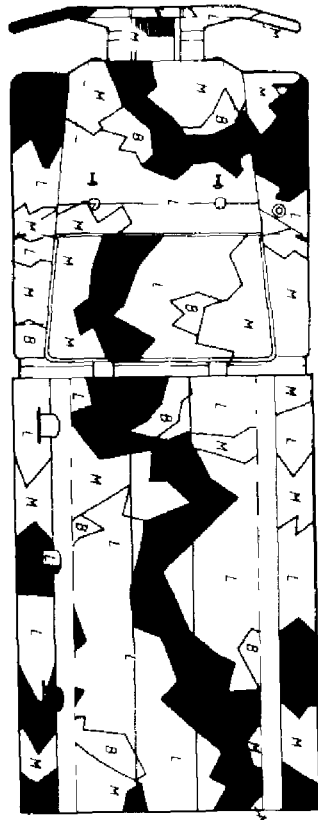
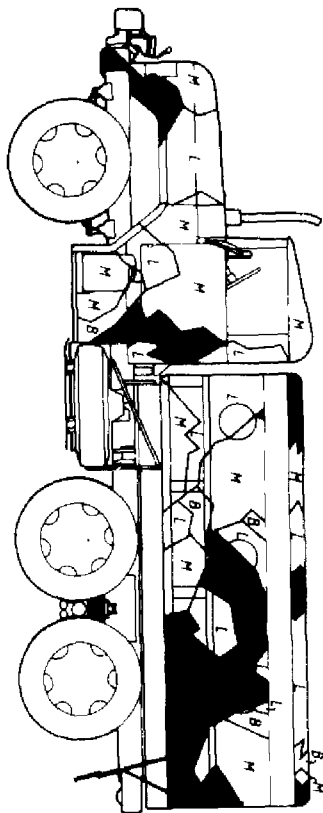
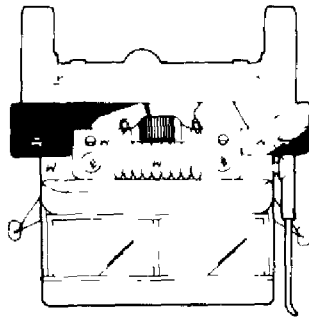

M 622

Vedlegg 4 til UD 9-17-3

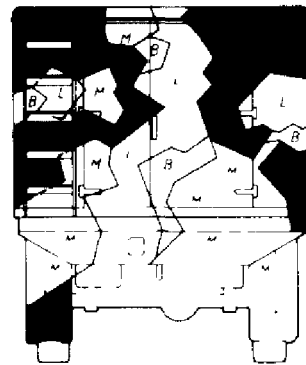
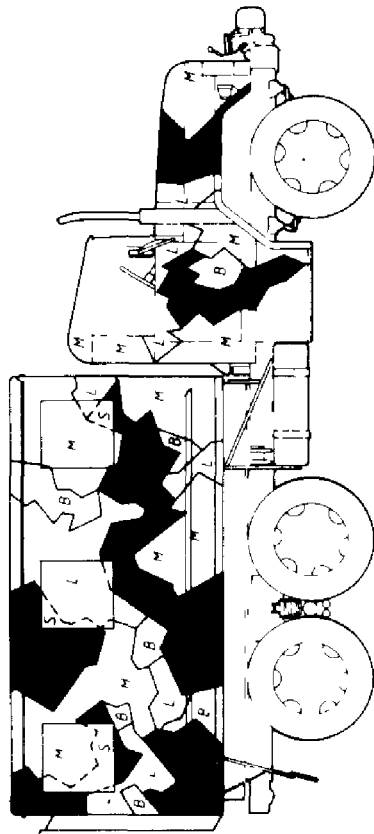
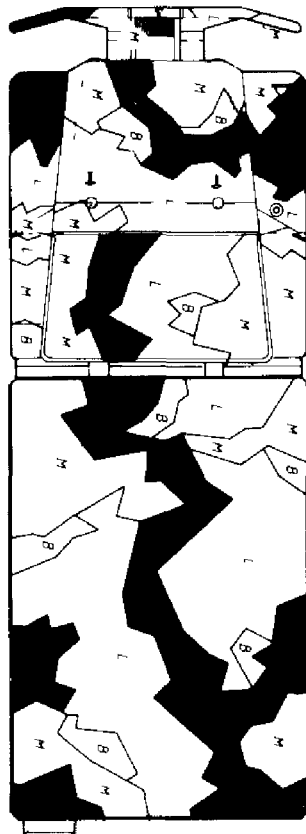
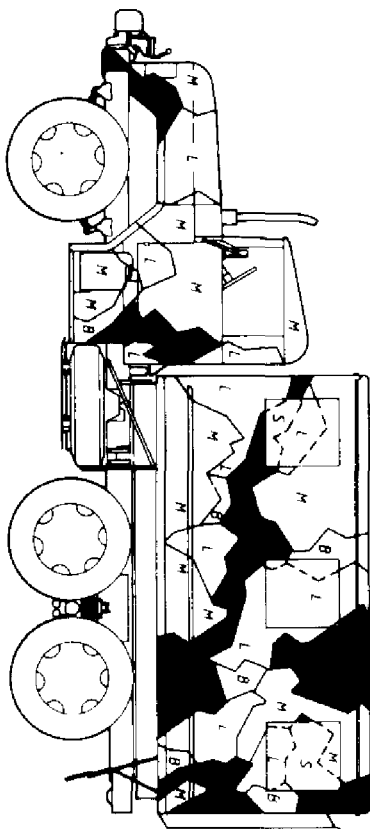
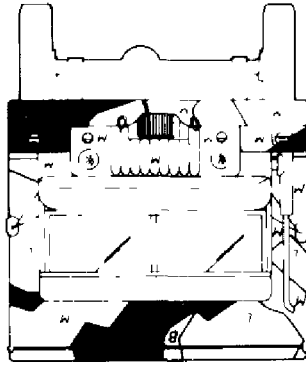

M 623

Vedlegg 4 til UD 9-17-3

TAKET PÅ FORERHUS MALES I SAMME  
MØNSTER SOM TAKSKJERM

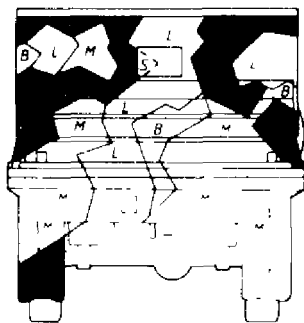
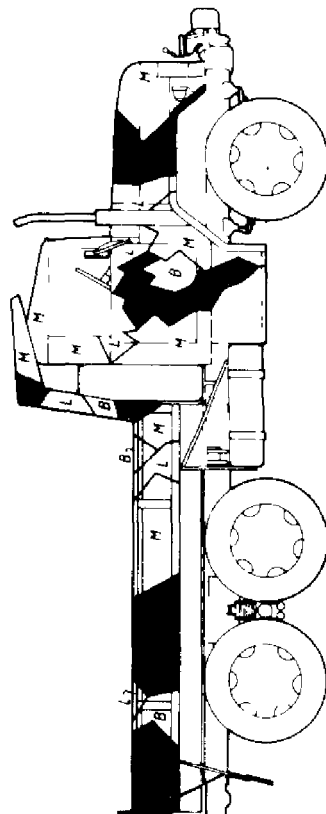
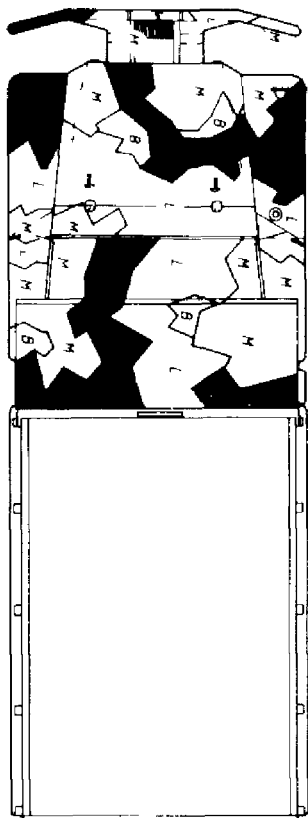
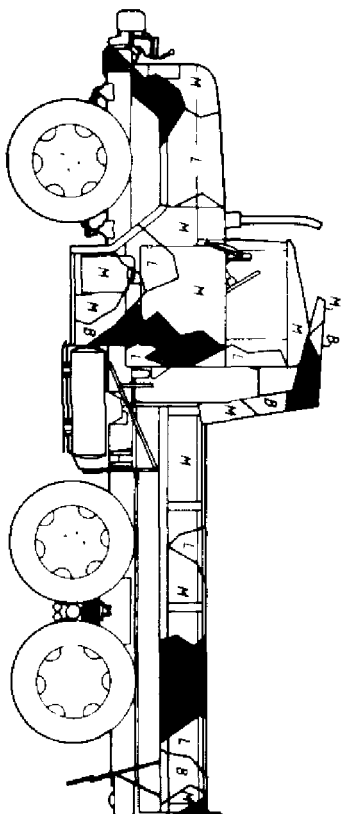
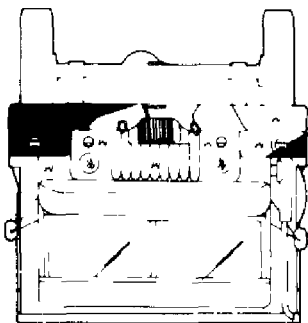

M 624

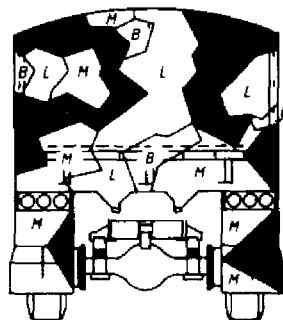
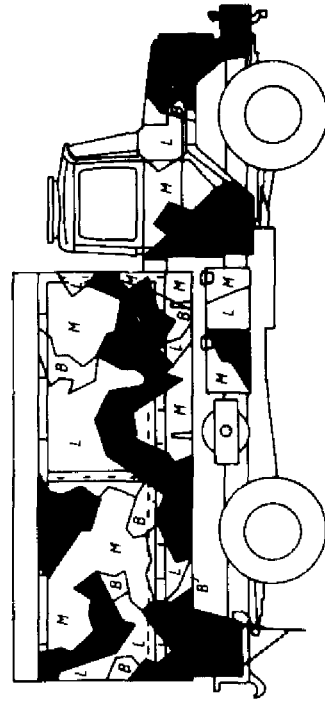
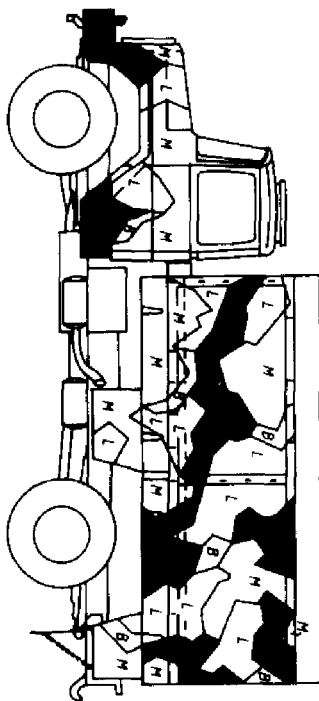
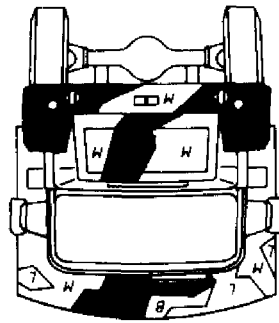

MAGIRUS 4x4

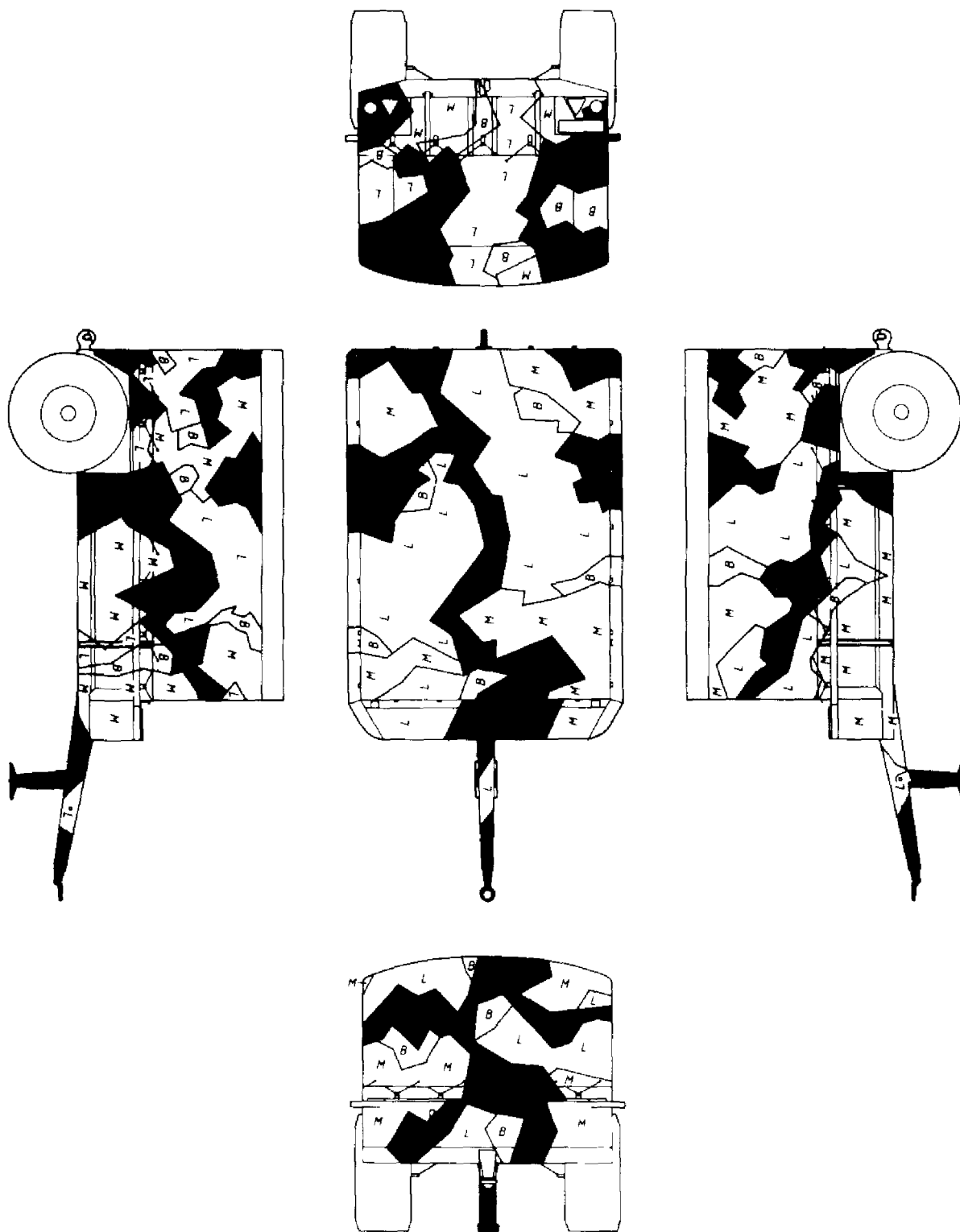

NM 25

Vedlegg 4 til UD 9-17-3

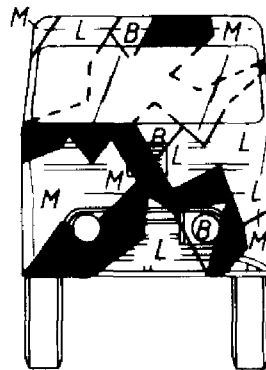
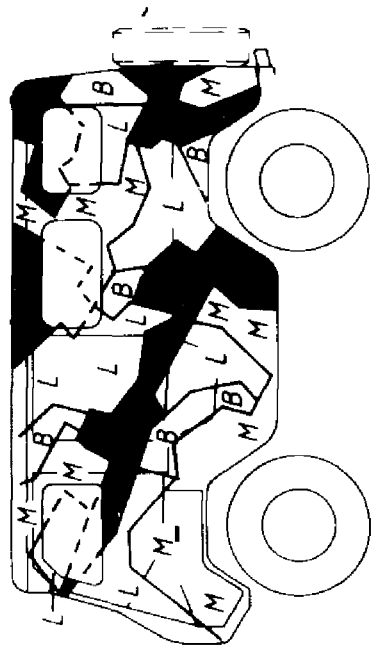
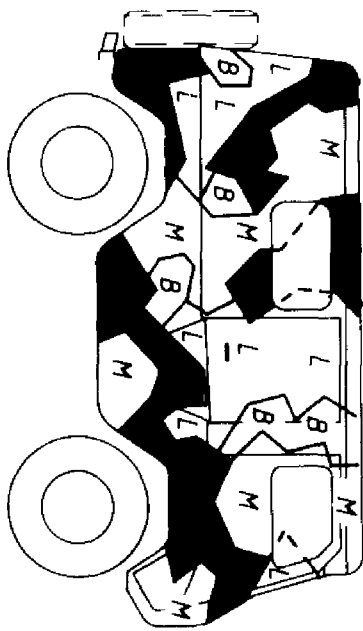

VOLVO 1/2 T 4X4

Vedlegg 4 til UD 9-17-3

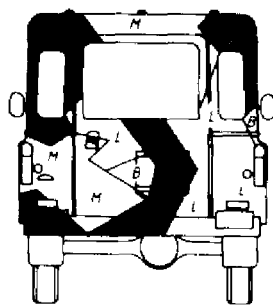
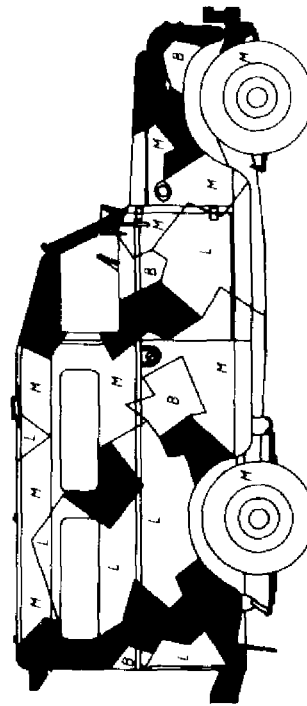
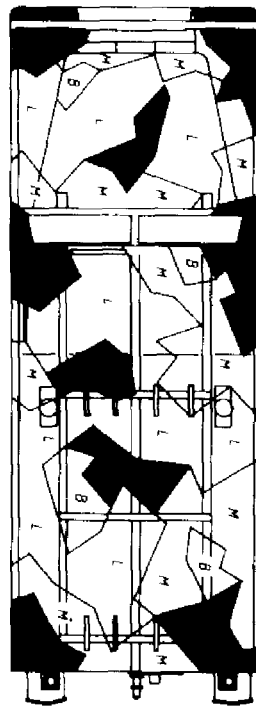
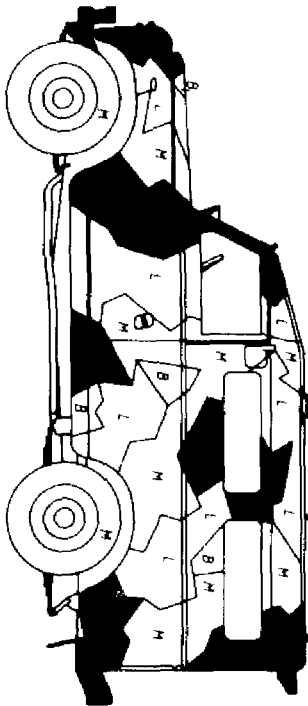
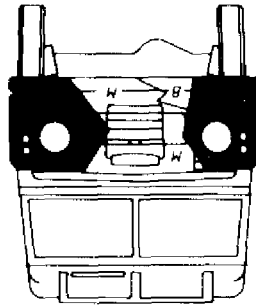

LANDROVER



## Vedlegg 4 til UD 9-17-3

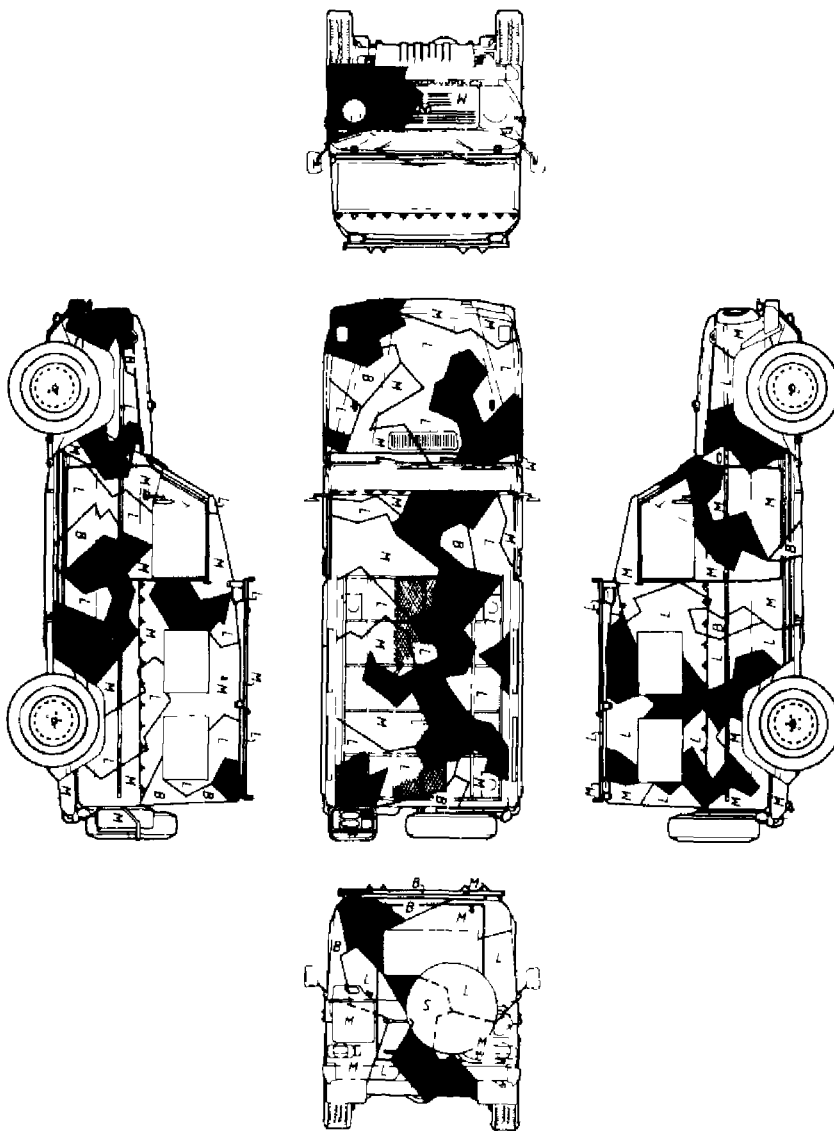

MERCEDES 240 GD

Vedlegg 4 til UD 9-17-3

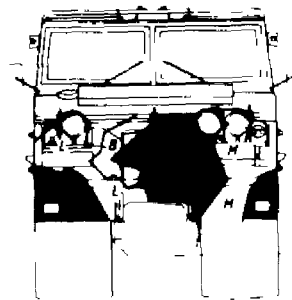
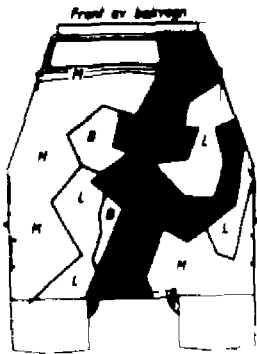
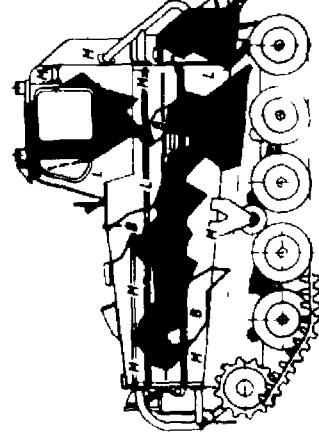
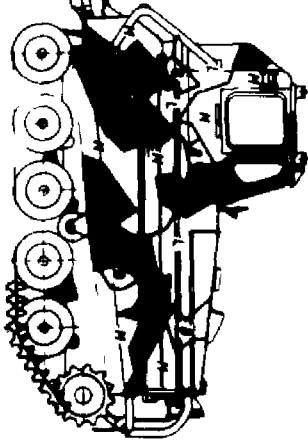
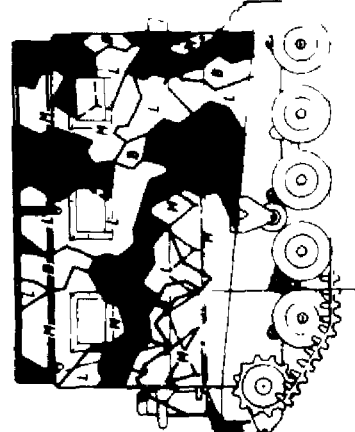
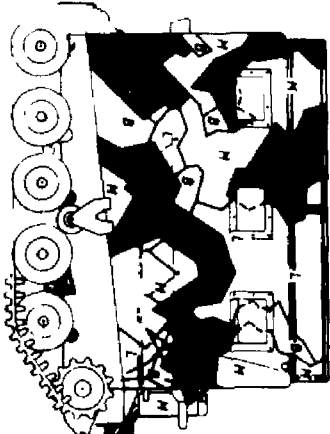
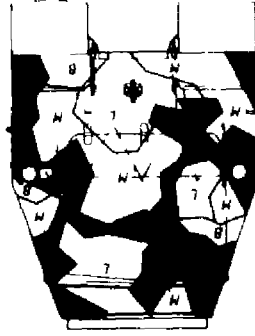

BV 202

Vedlegg 4 til UD 9-17-3

BAKENDE AV FRAMVOGN

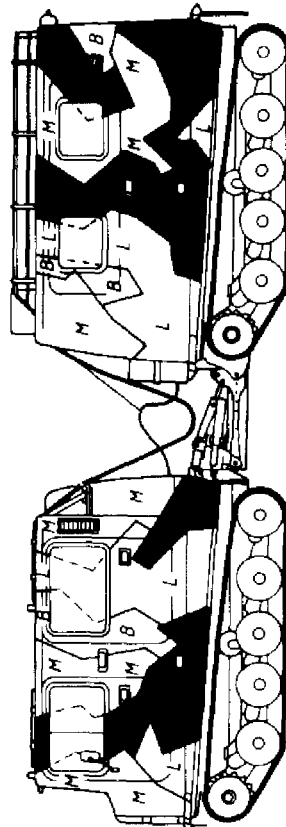
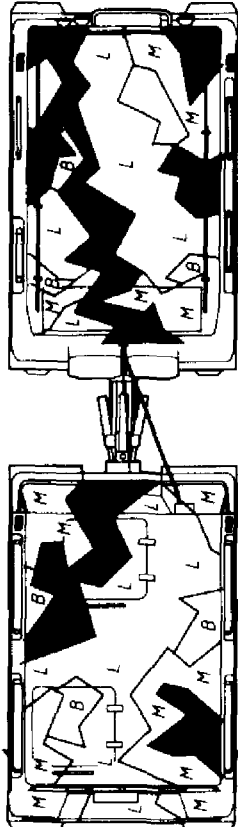
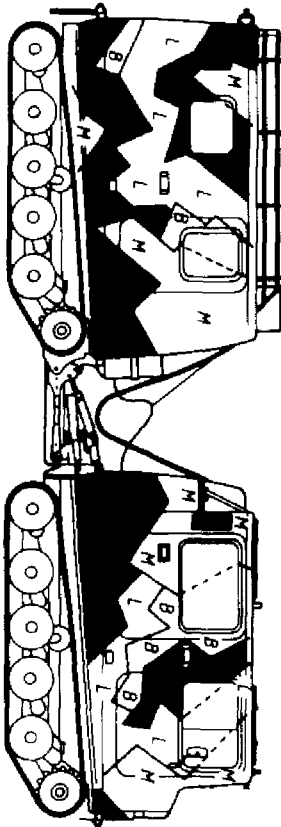
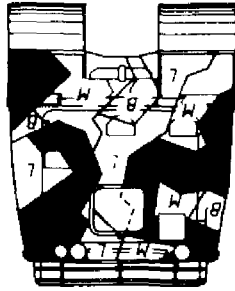
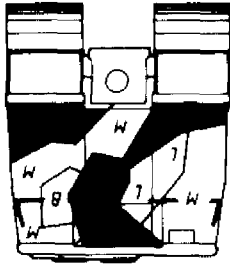

BV 206

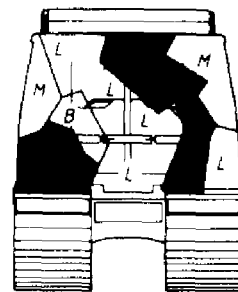
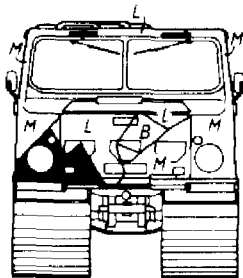

FRONT AV BAKVOGN

Vedlegg 4 til UD 9-17-3

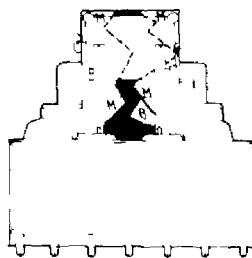
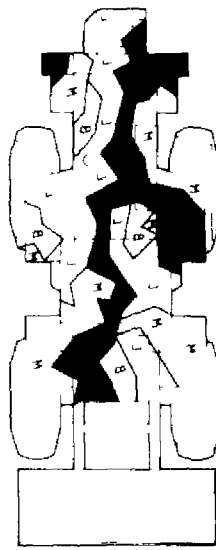
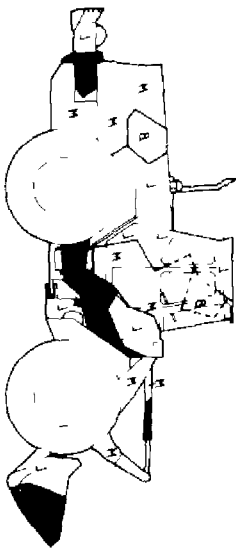
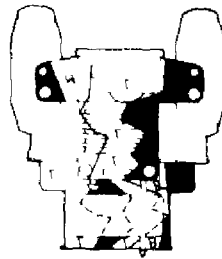

VOLVO LM 846

Vedlegg 4 til UD 9-17-3

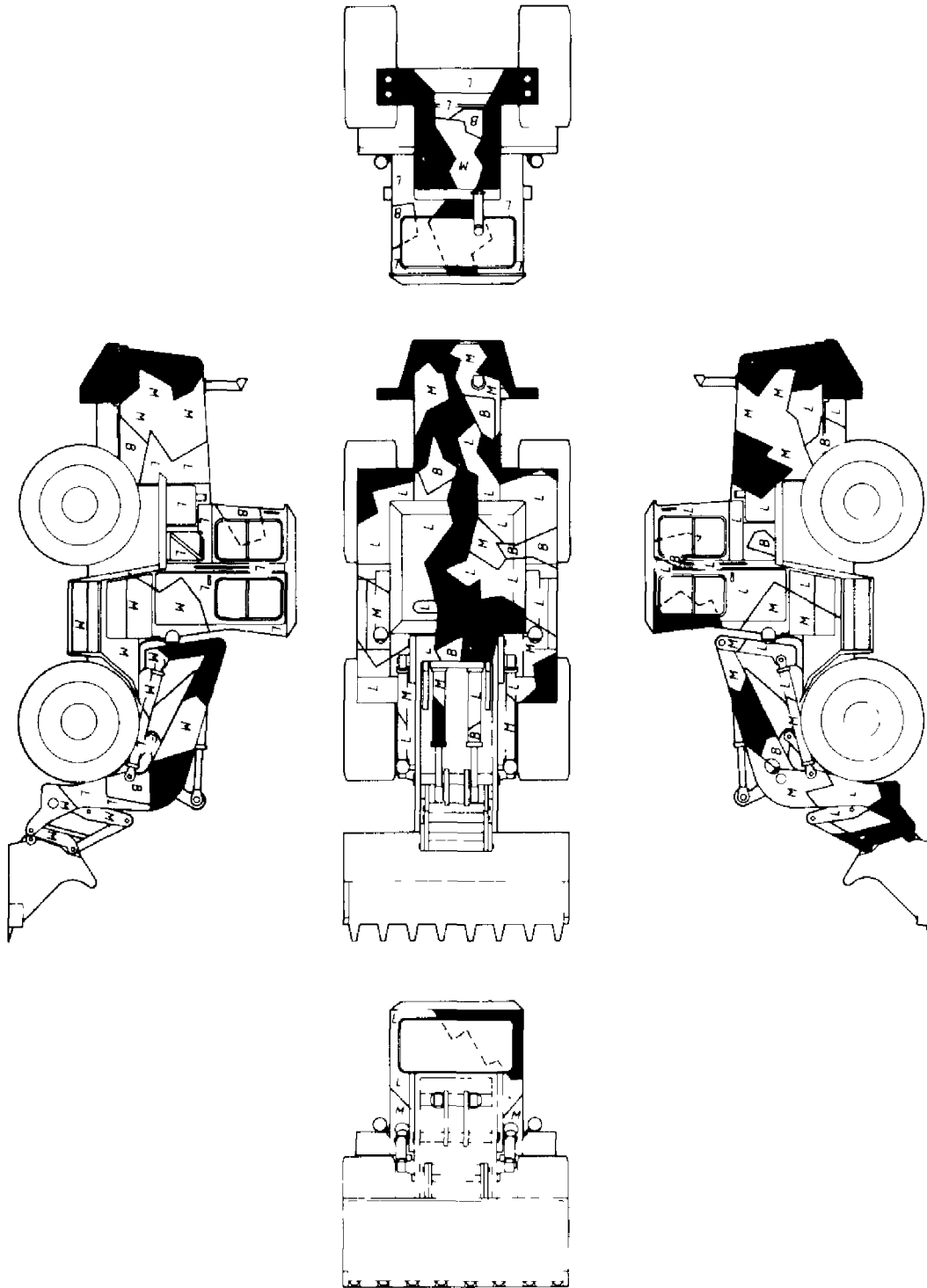

AHLMANN AS 12 B

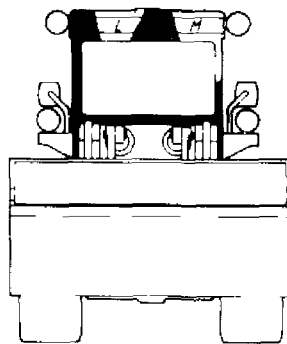
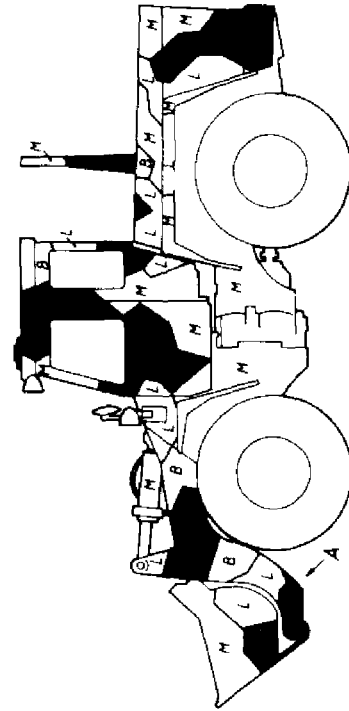
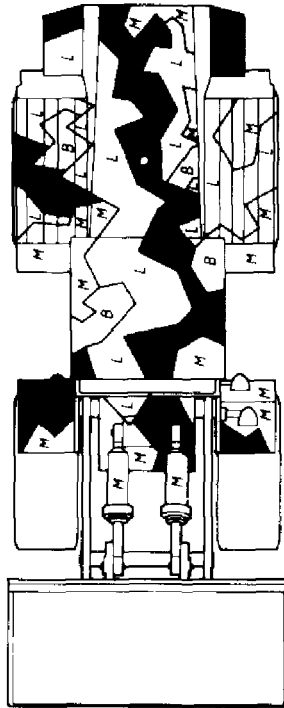
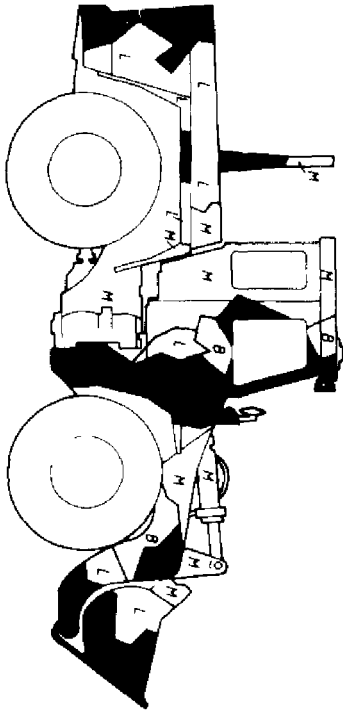
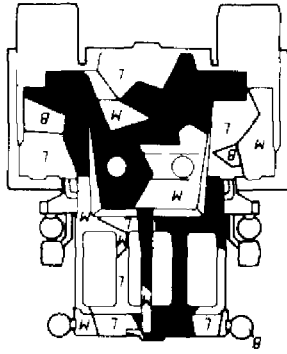

MF 33 C

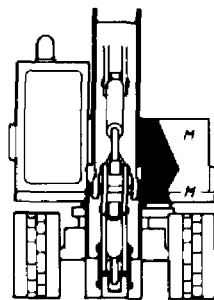
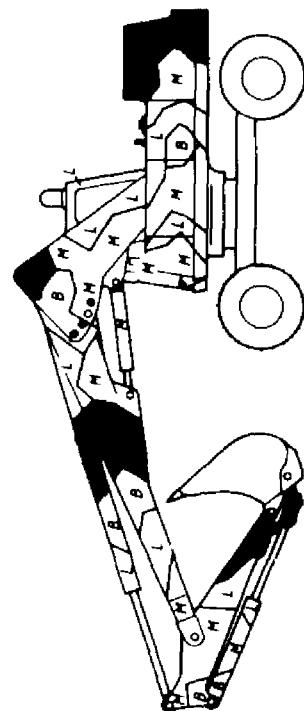
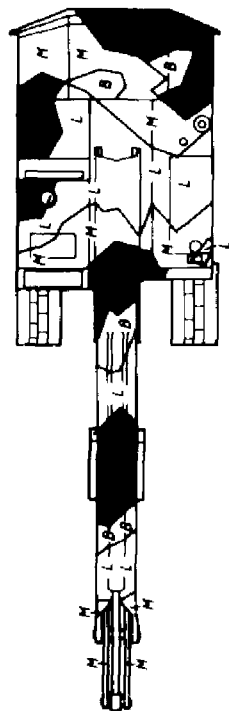
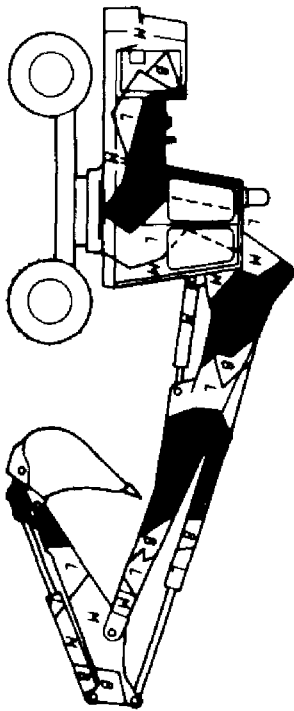
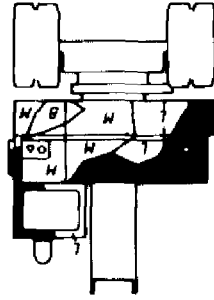

BRØYT X21

Maling under låret  
Tjener svinges og skroget under låret males  
samme mønster som oppå låret

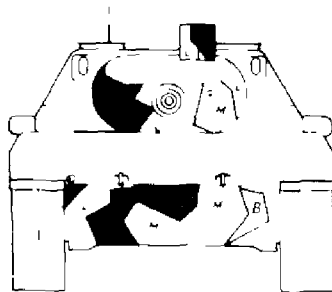
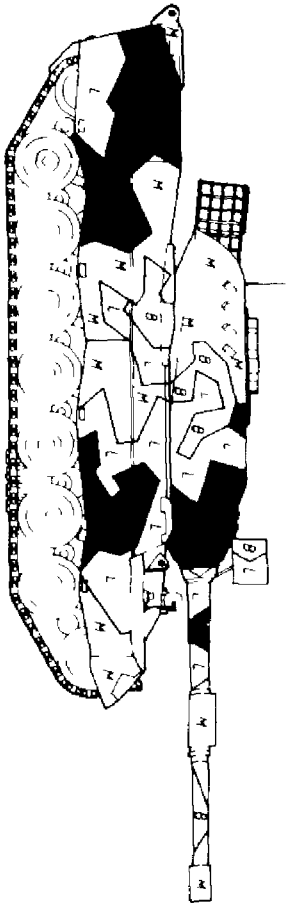
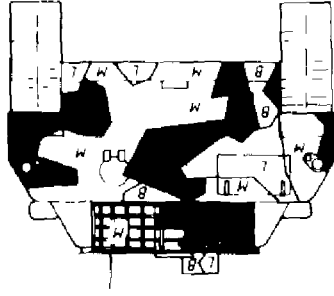

STRV LEOPARD



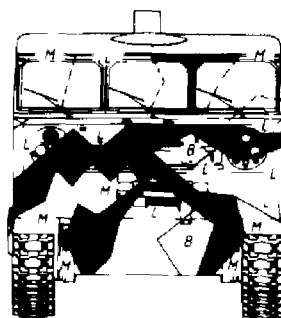
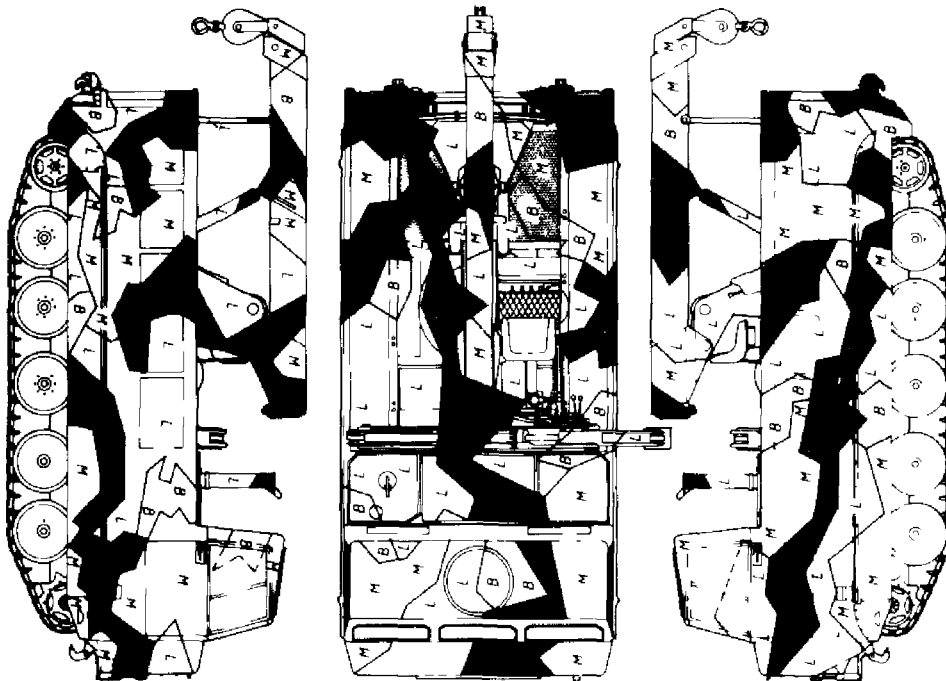
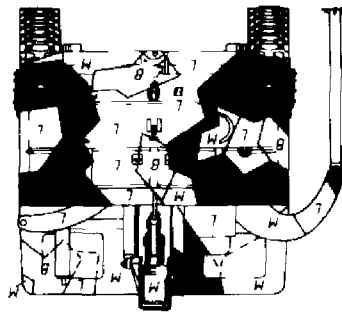

NM 84

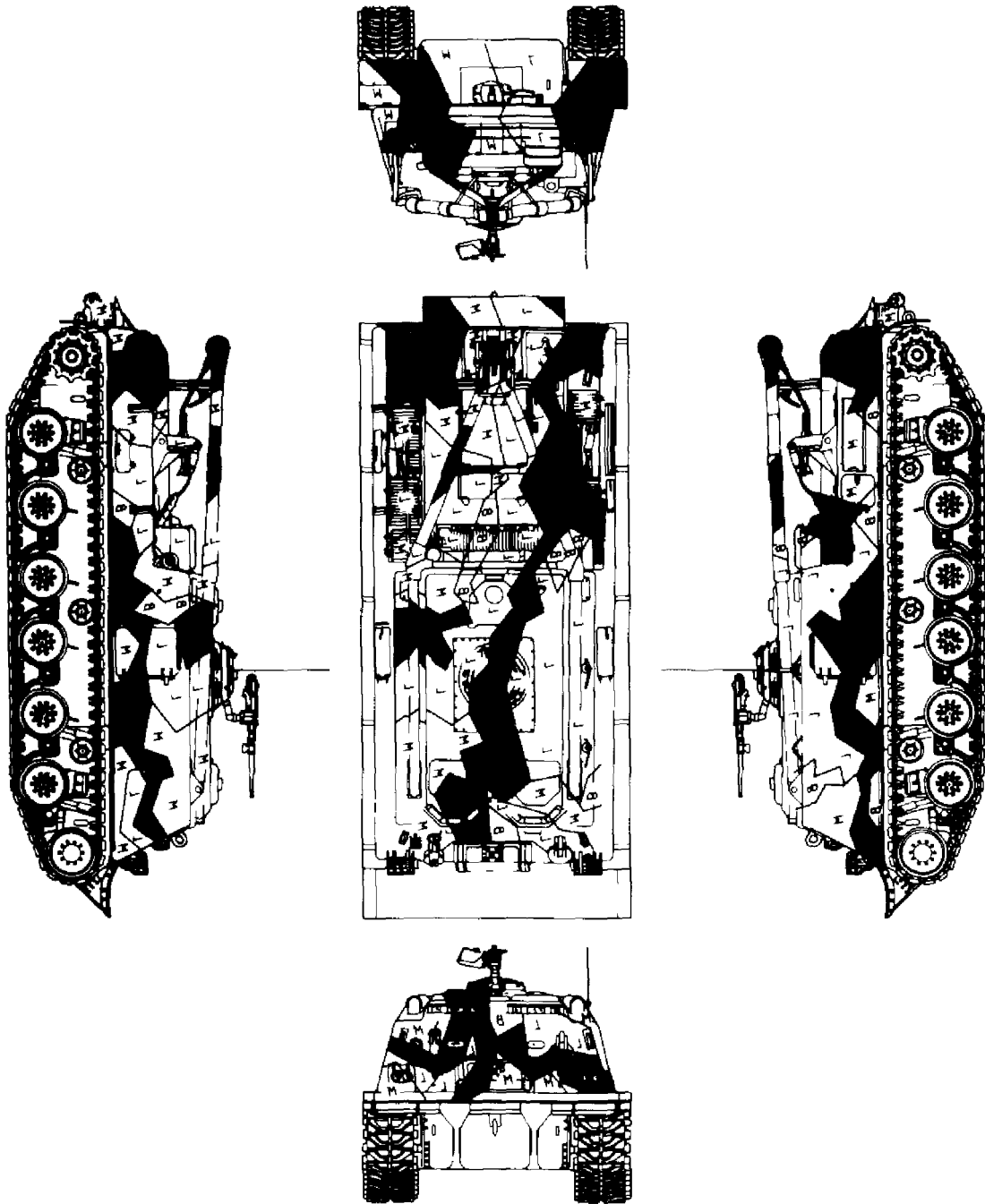

M 88 A 1

Vedlegg 4 til UD 9-17-3

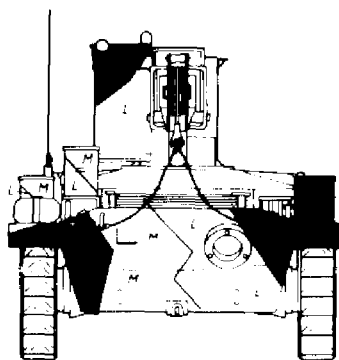
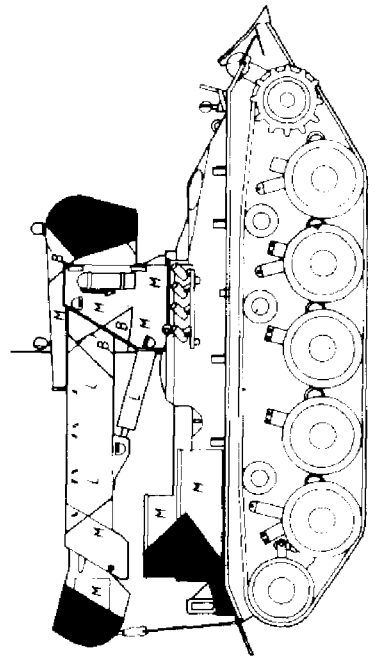
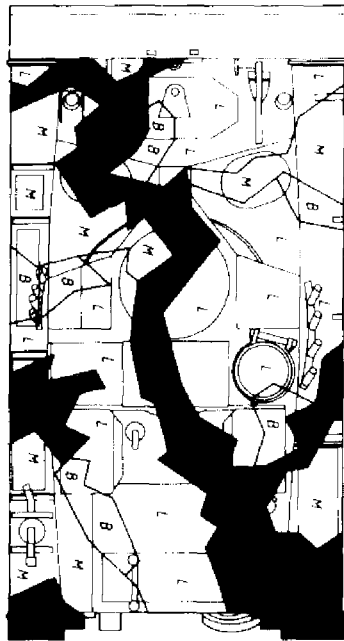
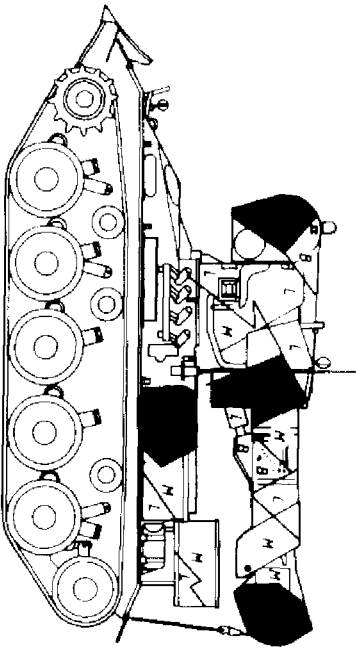
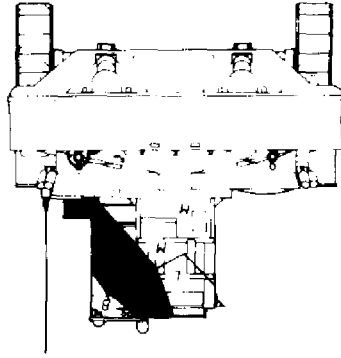

NM 130

Vedlegg 4 til UD 9-17-3

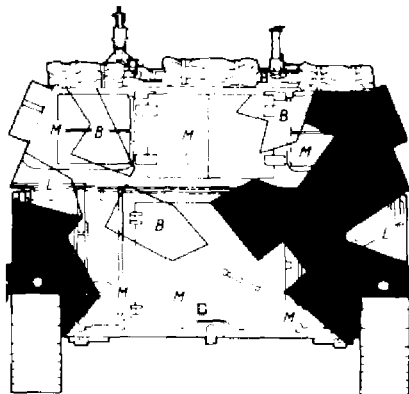
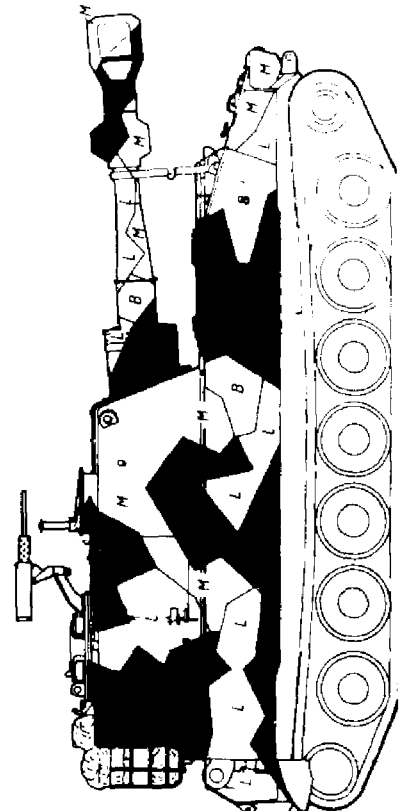
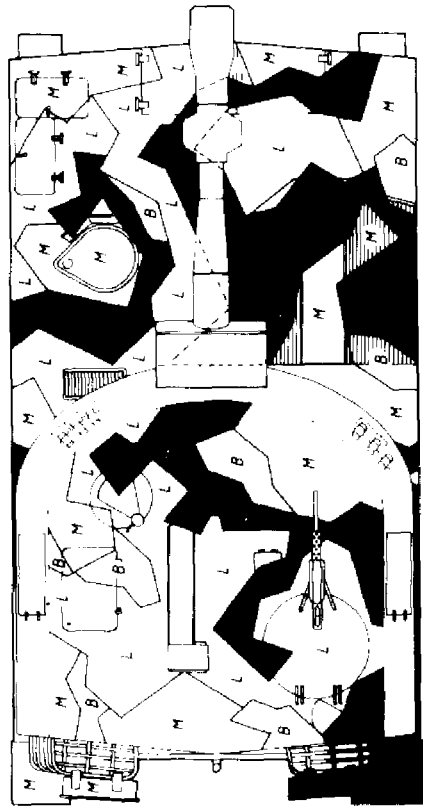
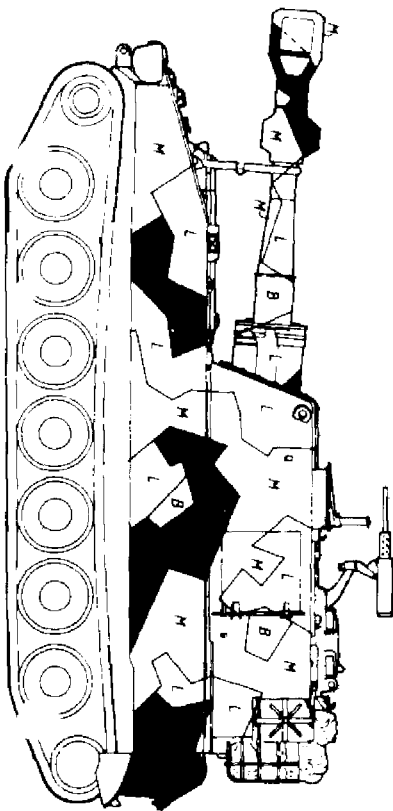
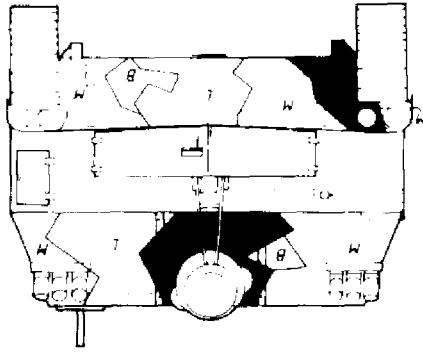

M 109 G

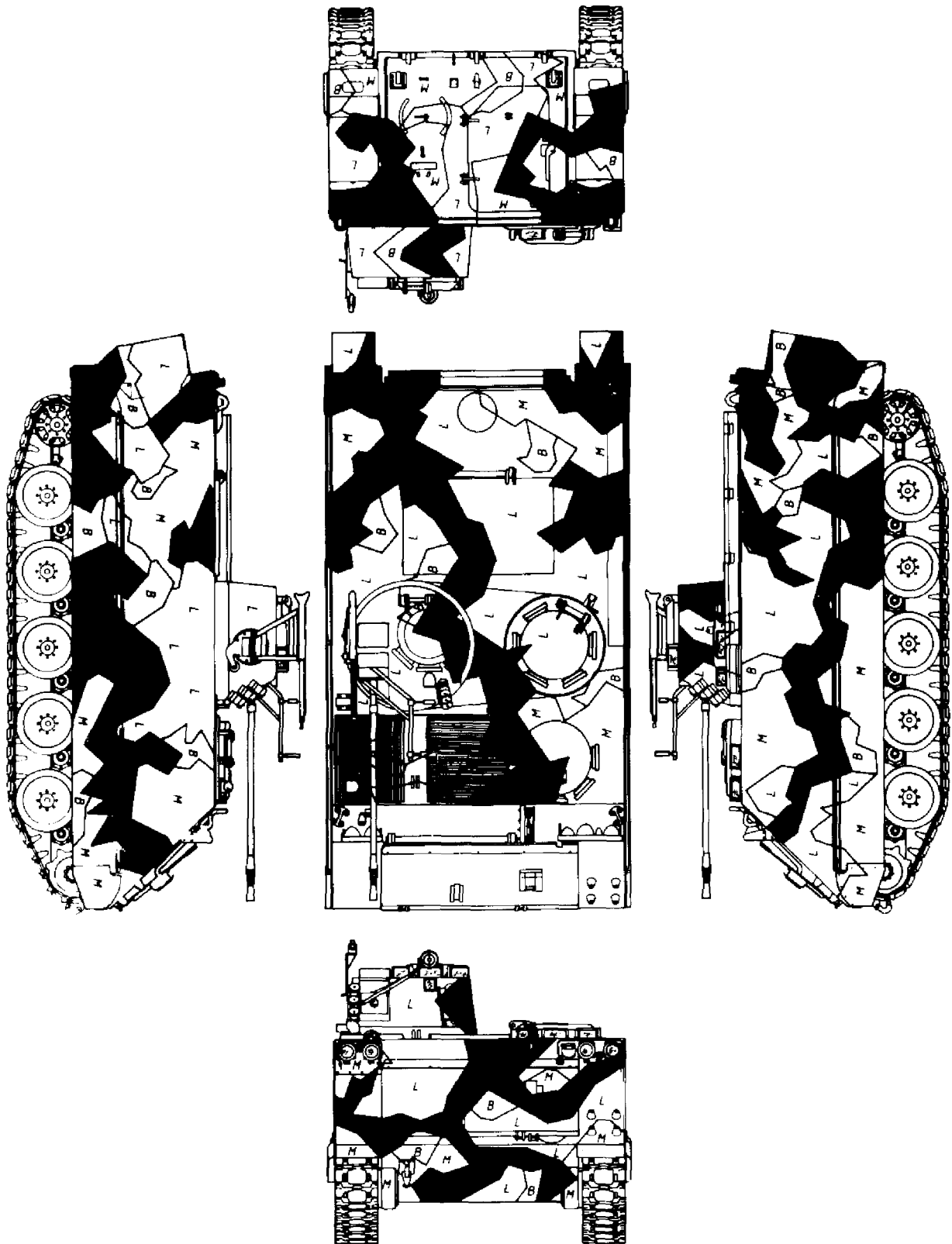

Vedlegg 4 til UD 9-17-3

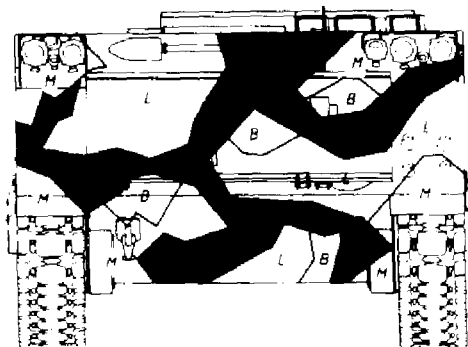
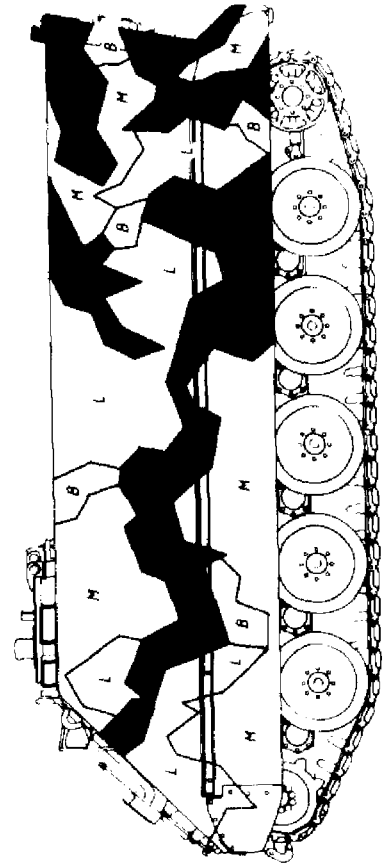
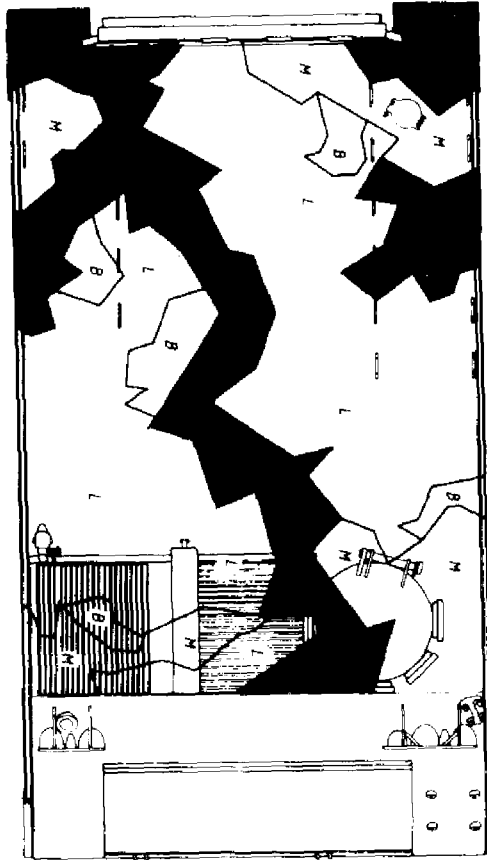
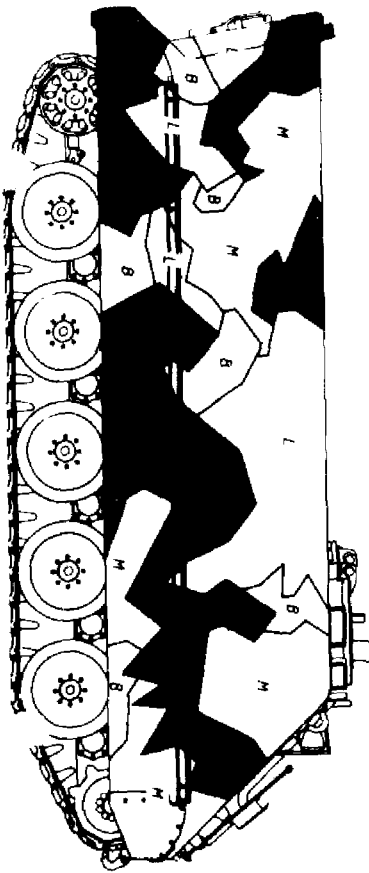
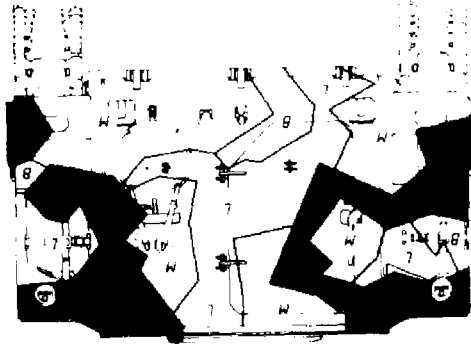

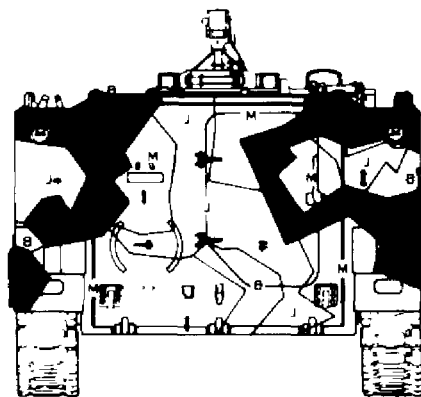
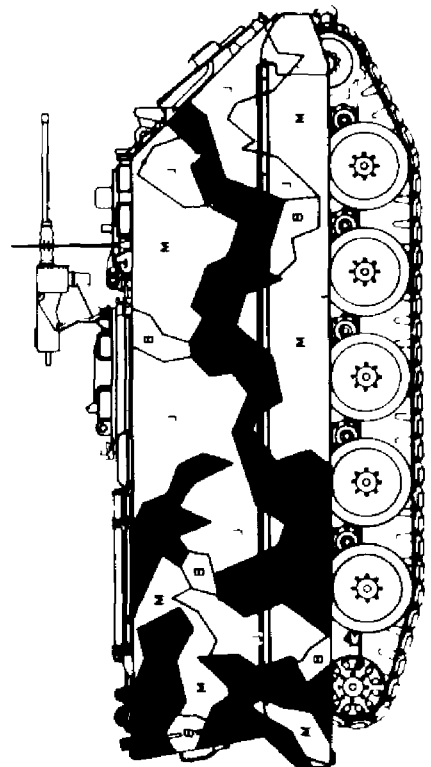
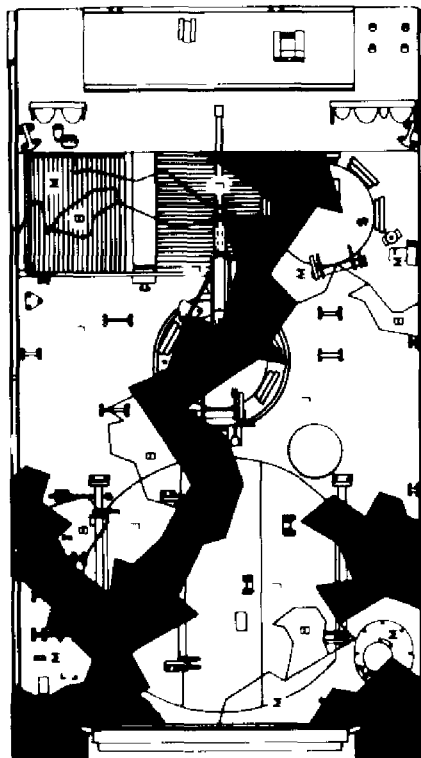
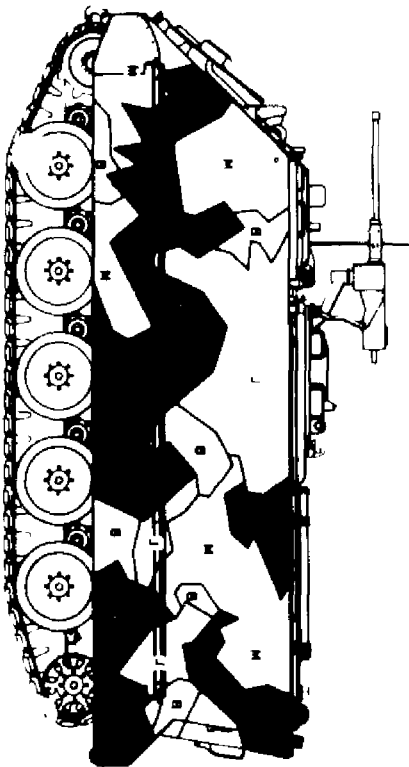
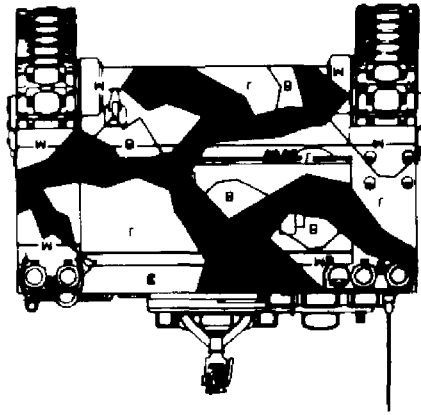

M 106

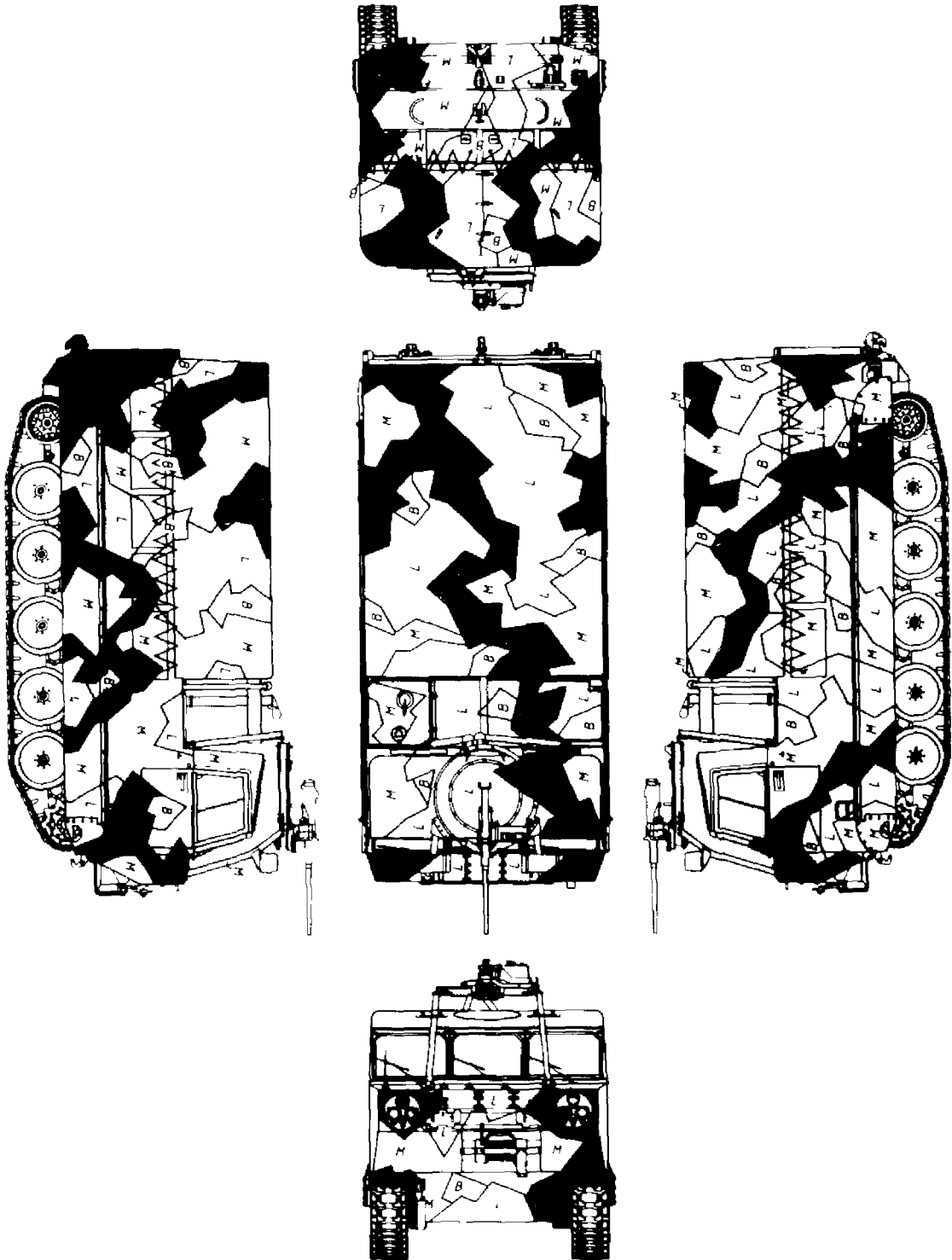

M 548



Vedlegg 4 til UD 9-17-3

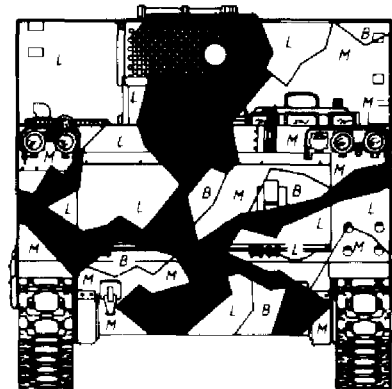
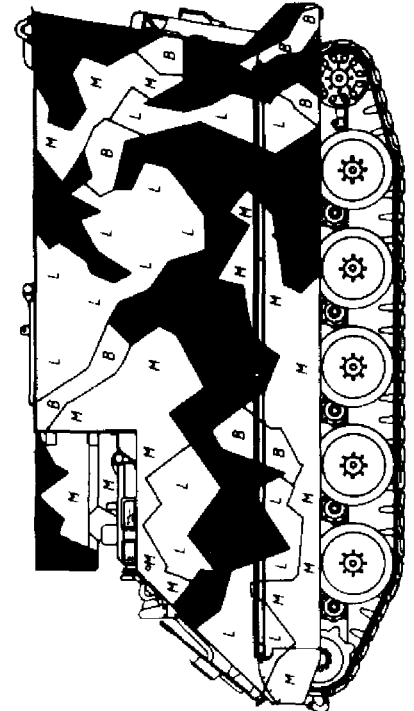
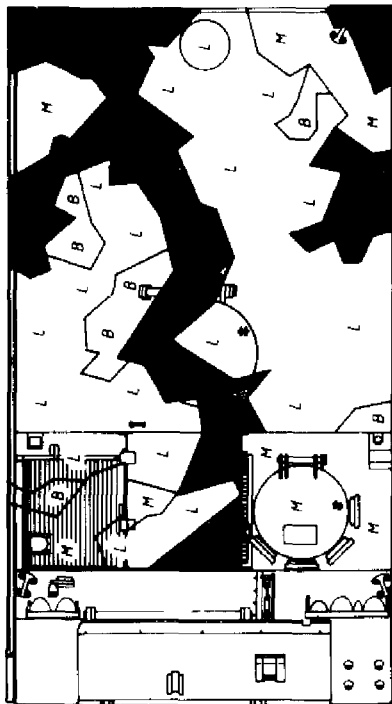
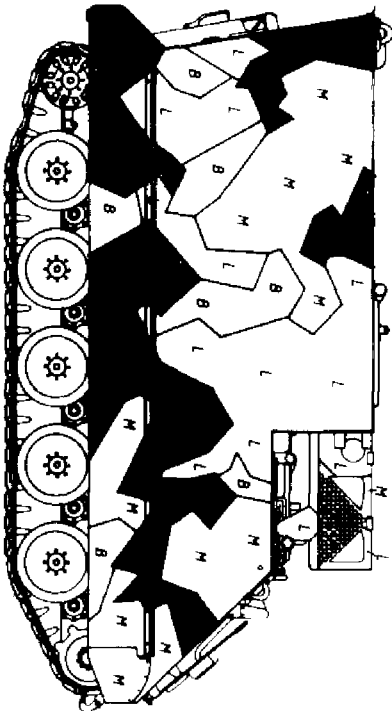
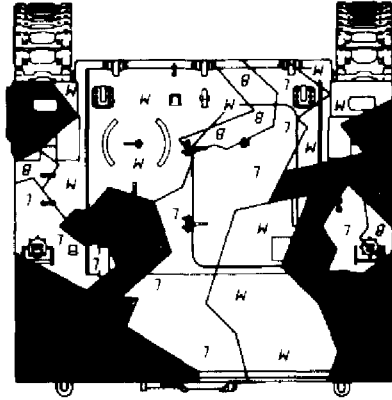

M 577

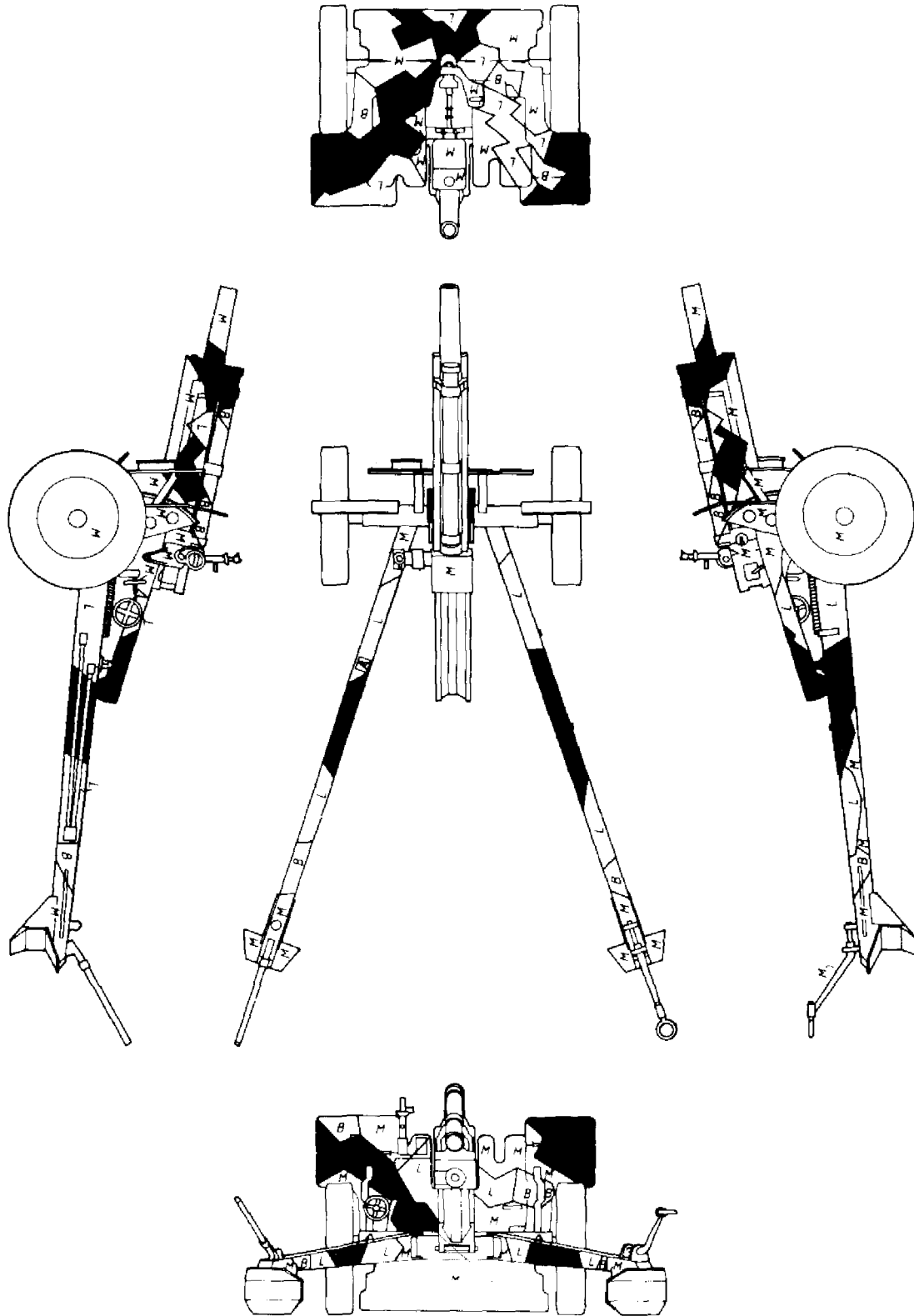

105 mm HAUBITS M 101

Vedlegg 4 til UD 9-17-3

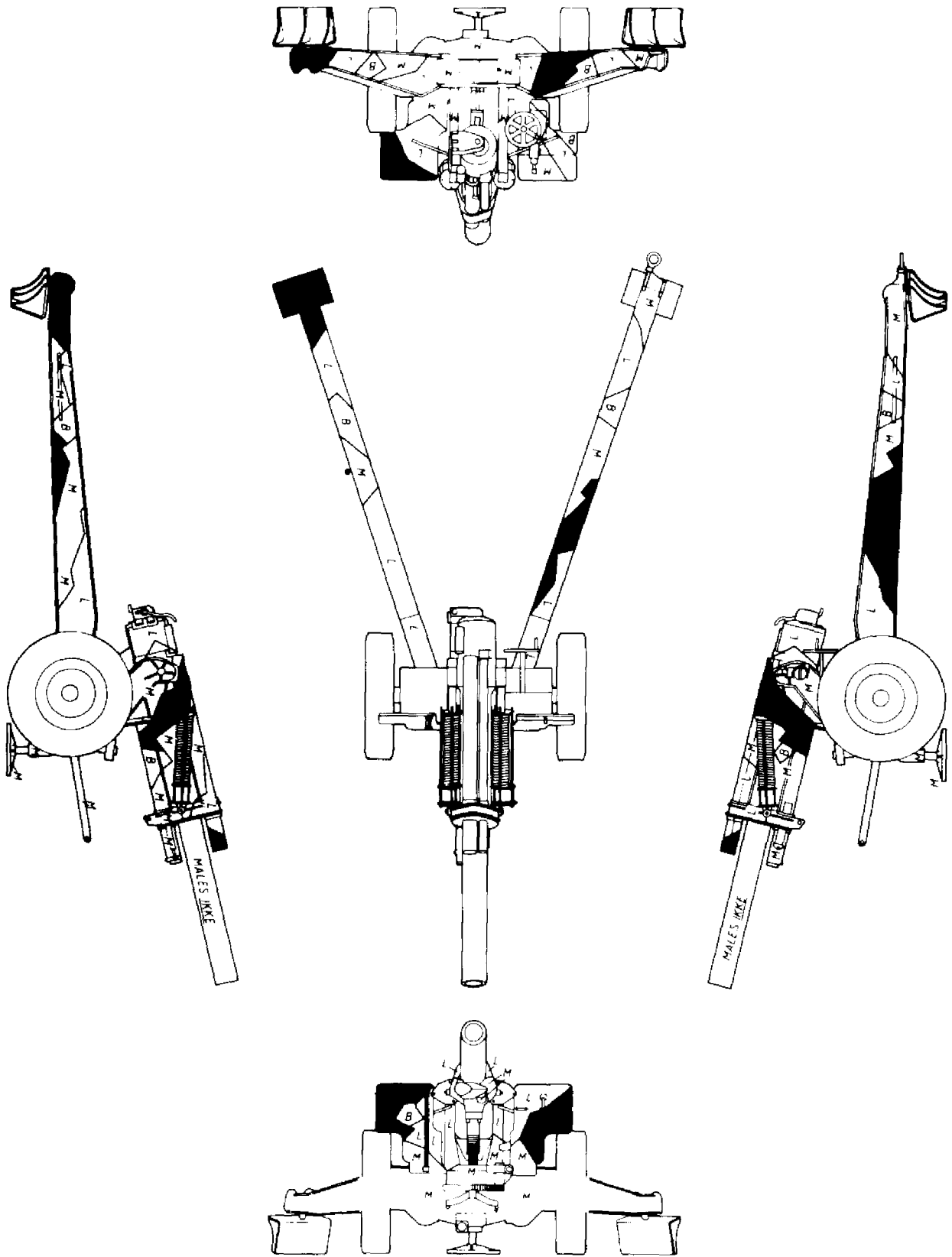

155 mm HAUBITS M 144

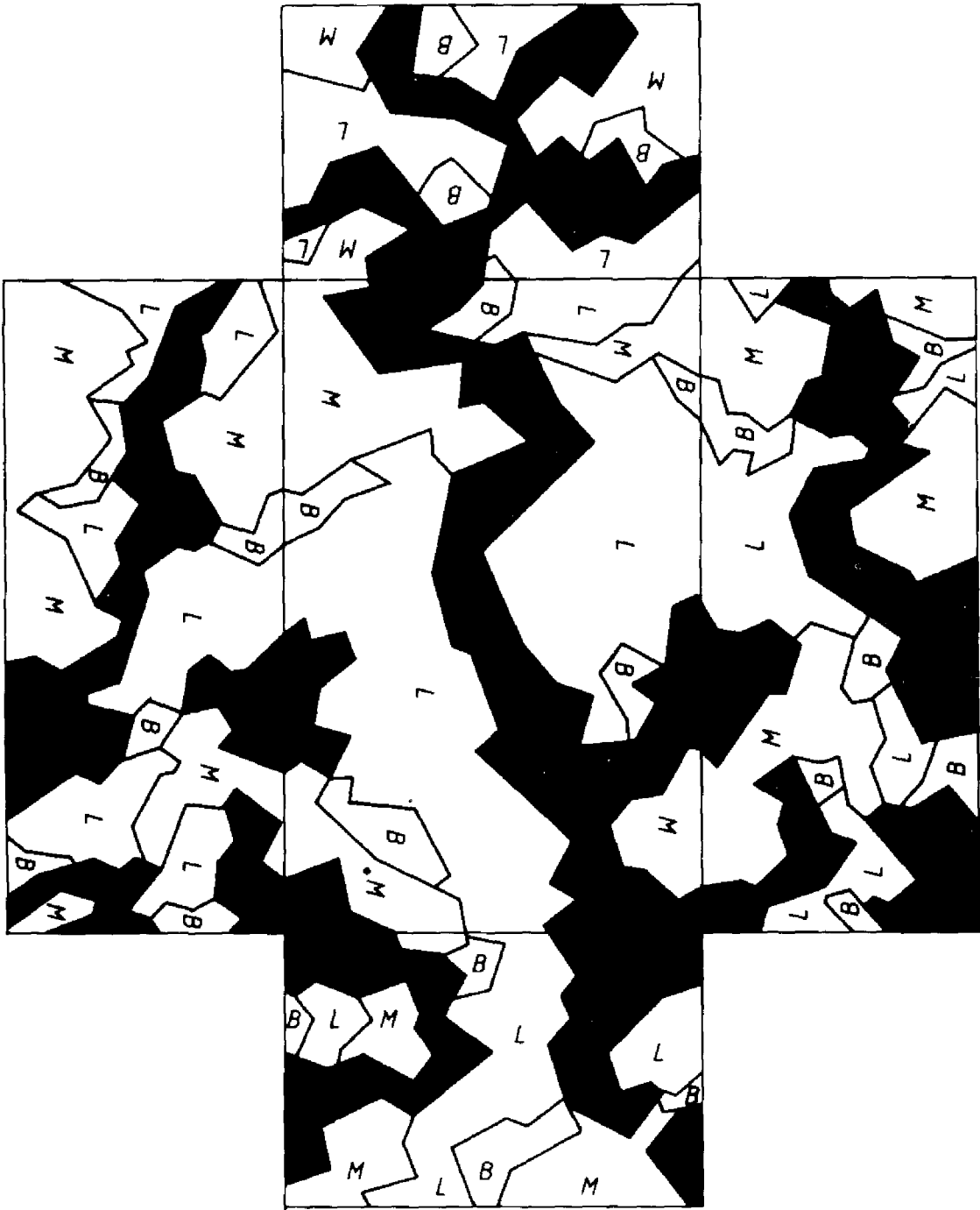

UNIVERSALMØNSTER